



MN101 Series MN103 Series & Development Environments

PanaXSeries®



Panasonic AM microcomputer series provides embedded controllers optimized for applications, and automotive fields.

Low power and high efficiency

Unique ReRAM technology

Ultralow voltage

Dedicated extended ALU

Low system cost

High-accuracy Analog ICs

High voltage ICs

On-chip EEPROM

Sensor

Battery, Touch panel, Smart meter, Camera, Watch



Applications

Power

Home appliance, Inverter, Digital power supply, Solar power



Automotive

Cockpit, Car body, HEV/EV



high-performance
mainly in sensor, power,



● Product range

	2009	2010	2011	2012	2013	2014	
Performance	32-bit MCU						
					MN103H Series ~120MHz		
		MN103S Series ~60MHz					
			MN103L Series ~40MHz				
	8-bit MCU						
					MN101L Series ~10MHz		
		MN101E Series ~20MHz					
		MN101C Series ~10MHz					



INDEX

- Microcomputer with Flash-memories ... 05
- Microcomputer with ReRAM (Resistive RAM) 07
- 8-bit AM1 (MN101) Series 09
- 32-bit AM3 (MN103) Series 11
- Microcomputer with Improved Resistance to Noise 13
- Development Environment
 - Optimized C Compiler 15
 - DebugFactory® Builder Version 5 ... 16
 - On-board Environment PanaX® EX Programming System ... 17
 - In-Circuit Emulator (ICE) 18
 - Real-time Operating Systems 19
 - Programming Tools Available from Panasonic Business Partners 20
- Package List 21

C Language Oriented Architecture

C

Develop systems efficiently in C

Program development is 3-10 times faster

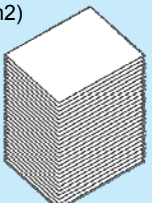
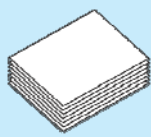
Past	Assembler program	Future	C language program
	Syntax dependent on the microcomputer		
	<pre> cmp(ram1),(ram2) bgt \$label mov (ram5),r0 sub (ram4),r0 jmp \$label2 label mov (ram5),r0 add (ram4),r0 label2 mov r0,(ram3) </pre> 		<pre> if(a>b) c=d+e; else c=d-e; </pre> 
			3-10 times the development time

The C programming language makes it easier and faster to program large systems, but generates more code than assembler. Larger code size in turn means higher ROM costs and slower execution speed. Panasonic eliminates this tradeoff with its C language-oriented microcomputers, which combine a true microcomputer architecture with a highly optimized C compiler to achieve unprecedented code efficiencies. This combination minimizes the size of the resulting code while retaining the threefold to tenfold development speed advantage afforded by the C programming language. The approach yields efficient system development in C over the entire range of 8- and 32-bit microcomputers.

C Language Oriented Microcomputer for

[Higher Performan

High Performance

High

Single-cycle execution for higher throughput AM3 (MN103) instruction code assignment

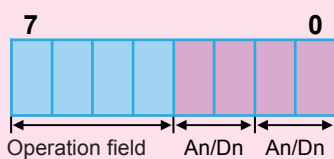
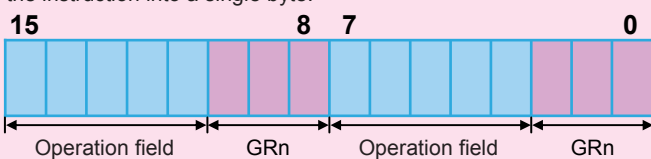
New instruction code assignments	Conventional code assignment for general register instruction
Basic instructions (register-to-register operations, load/store operations) fit within a single byte.	Because register field take up six bits, it is impossible to fit the instruction into a single byte.
	
An: Address register field Dn: Data register field GRn: General register field	

The register set represents a careful balancing of hardware needs against C compiler code generation efficiency. From the eight available registers, the instruction format requires four bits to specify registers. As a result, the architecture assigns the basic instructions most frequently used in C code to single bytes. The compiler uses register optimization techniques to maximize the efficiency of register usage. Finally, a high-performance pipeline executes these instructions at the rate of one every machine cycle.

Low Power Consumption

Low

**Optimized internal bus design lowers power consumption
AM1 (MN101) bus conversion**

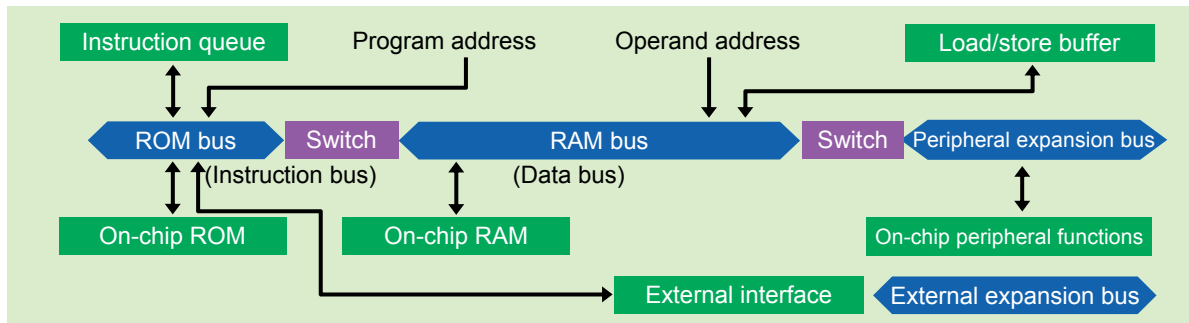

The CPU features separate buses for instructions and data, and even provides a separate bus for expanding the latter for use with on-chip peripheral functions.

ce] + [Faster Development]

We Match Your Needs. You Don't Have to Match Ours.

Result : Greatly Reduced System Costs

Using an AM Series C language oriented microcomputers

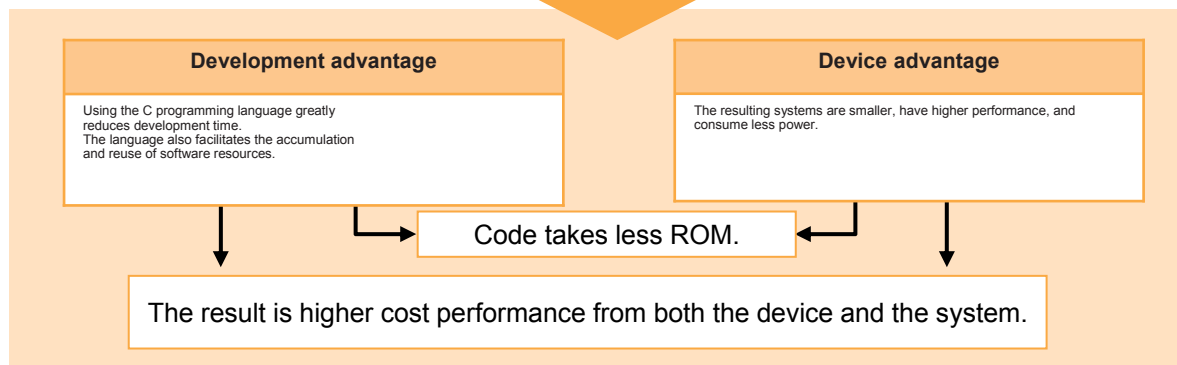

These C language oriented microcomputers (the AM Series) offer twin advantages to system development. First, they permit program development in C, a language that cuts development time. Secondly, they help reduce system costs by fitting programs into smaller ROM spaces. The result is higher cost performance from systems that are smaller, have higher performance, and consume less power.

Microcomputer with Flash-memories

The World Expanding with Flash Microcomputers

Microcomputers with Flash Memory

Microcomputers equipped with flash memory - rewritable - is indispensable to shorten the development lead time and rewrite the program implemented into end products.

Panasonic microcomputers with flash memory feature high performance and low power consumption, allowing you to develop excellent products in a short lead time.

Shortens the lead time

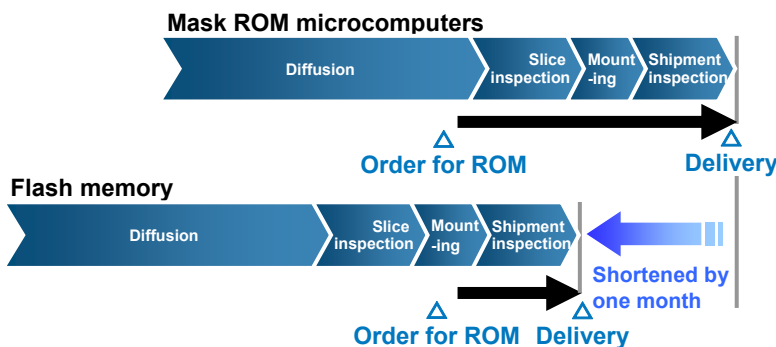

Number of pins and ROM capacity

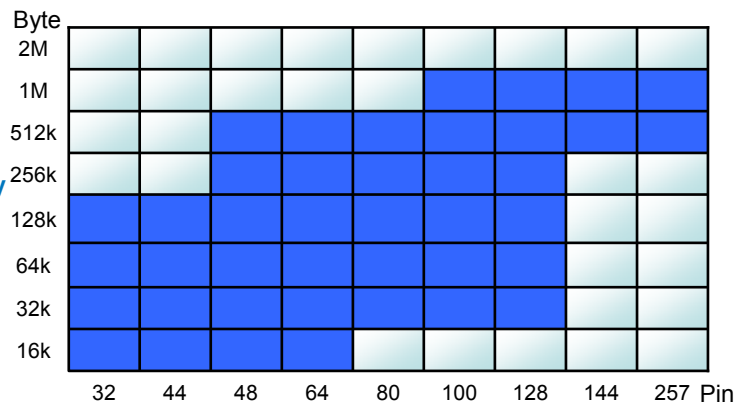

Microcomputers with 110 nm Flash Memory Feature High Performance and Environmentally Friendly Operation

The transition from a 0.18 μm process to a 110 nm process provides higher system performance and more environmentally friendly operation.

Thanks to a newly developed mixed process for producing flash memory specifically for use in microcomputers, Panasonic microcomputers equipped with 110 nm flash memory deliver smaller area, lower power consumption, higher reliability, and faster operation than previous models equipped with 0.18 μm flash memory.

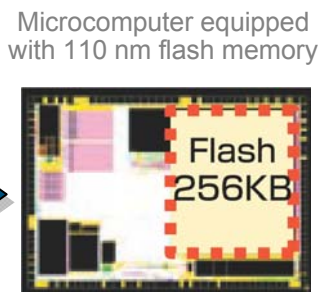
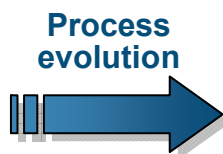
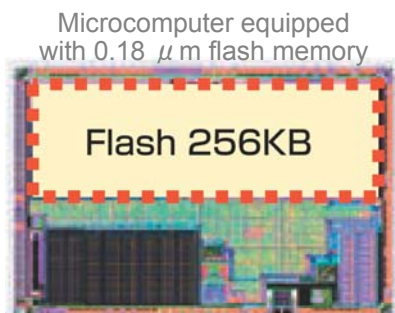

Flash memory occupies 40% less area

110 nm flash memory microcomputer features

* Percentages indicate performance relative to Panasonic 0.18 μm models.

Low power consumption

- Operating current: 30% lower
- Slow current: 90% lower

Vehicle on-board electrical component characteristics

- Sufficient quality for high-temperature (125°C) on-board application

Rewriting characteristics

- Number of rewrites: 100,000
- Rewrite time: 50% faster

High-speed operation

- Maximum operating frequency: 120 MHz

Secure Guard of Important Software

Reliable Security Function

Equipped with a protection function to prevent unauthorized access to ROM code

- A key code (128 bits) storage area is provided.
- The key code must be authenticated using an exclusive command to read the ROM data.
- Only one setting of key code is available.
- Shipment is possible with security information set.

The flash core has a 128 bit key code. Writing this key code prevents the ROM data from being read by third parties.

The key code can be written only once. The flash memory with a key code written to it cannot be accessed unless the key code is authenticated.

Accordingly, persons that do not have the key code cannot read the ROM data using programming various tools.

Executing instructions from the CPU or reading ROM data via executed commands are, of course, possible without the key code.

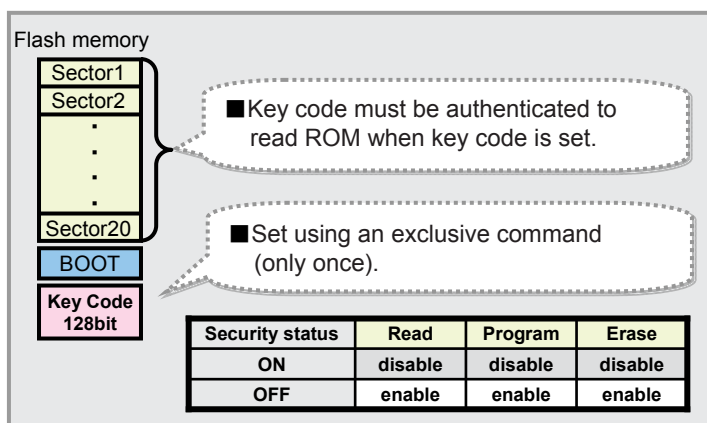

Protection Function

The writable area is limited to protect data even when the microcomputer has runaway.

- A protected data storage area is provided.
- Each sector is protected using an exclusive command (only once).
- Shipment is possible with protect data set.
- The protected sector cannot be rewritten.

The flash core has a protection function. This function prevents the flash memory from being rewritten accidentally even when the microcomputer has runaway.

Once the protection for the protection data area is set to [ON], each sector can be protected. The protection data area can be written only once.

The protected sector cannot be rewritten, so the memory data will not be damaged even when the program has runaway.

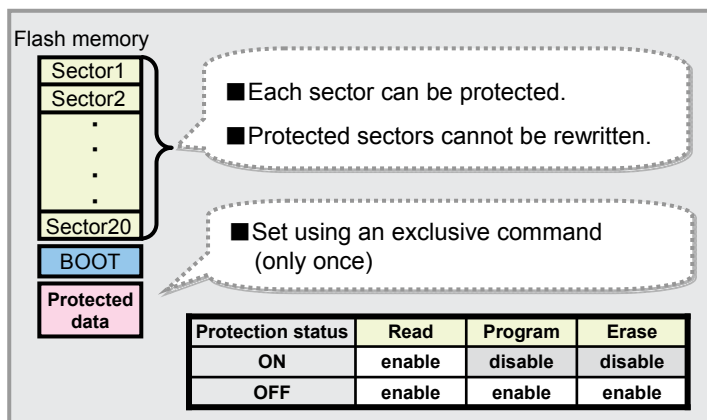

Microcomputer with ReRAM (Resistive RAM)

Industry's First Resistance-Change Memory, New 8-bit Core, and Low Leakage Process Deliver Low Power Consumption.

Microcomputer with new non-volatile memory ReRAM developed

Panasonic has developed an industry's first new non-volatile memory ReRAM. The 1T1R-ReRAM memory is fabricated by the CMOS process with 0.18- μ m low power consumption ReRAM, enabling readout at low-voltage and fast memory cell rewriting at 10 ns. Microcomputer with ReRAM reduces power consumption of applications, in particular allowing longer battery life and downsizing for environment infrastructure equipment, such as smart meter, and mobile devices, such as smart phone requiring low power consumption.

1T1R-ReRAM Memory Cell

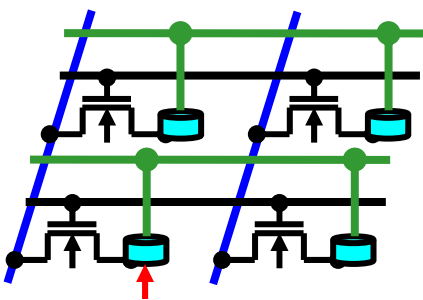

Resistance-change element

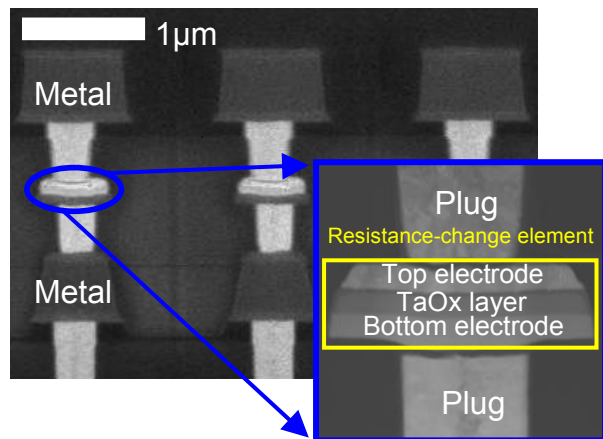

Mechanism of ReRAM Memory

ReRAM is a device capable of changing its resistance at intervals of at least 10ns and holding the value, therefore allowing high-speed rewriting. Furthermore, it can be easily applied to fine process and has a potential leading to large memory capacity.

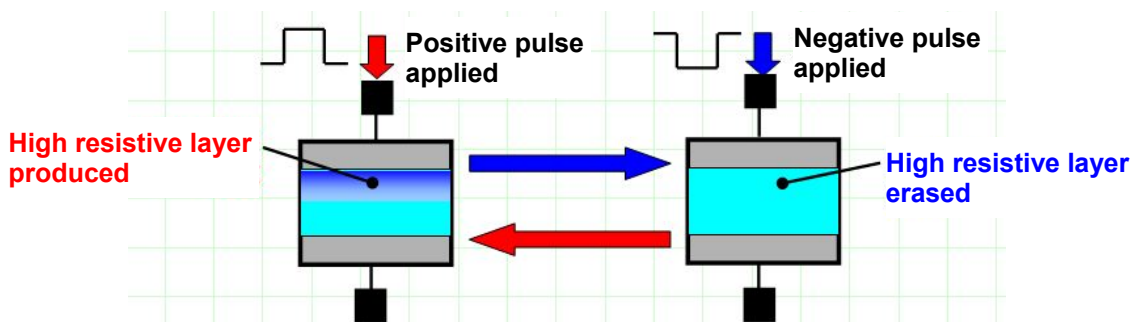

Comparison of ReRAM Memory and Flash Memory

Items	ReRAM memory	Flash memory
Operating principles	Resistance change by oxidation and reduction	Charge injection and ejection by high voltage applied
Features	<ul style="list-style-type: none"> ① Power-saving readout ② Rewritten in units of bytes ③ High-speed rewriting 	<ul style="list-style-type: none"> ① Space-saving and large capacity ② Written in units of bytes, but erased in units of sectors

Features of Microcomputer with ReRAM

Rewriting Property

- Unlike flash memory or EEPROM, no data erase required
- Over 5 times faster rewriting than flash memory or EEPROM (See the figure below.)

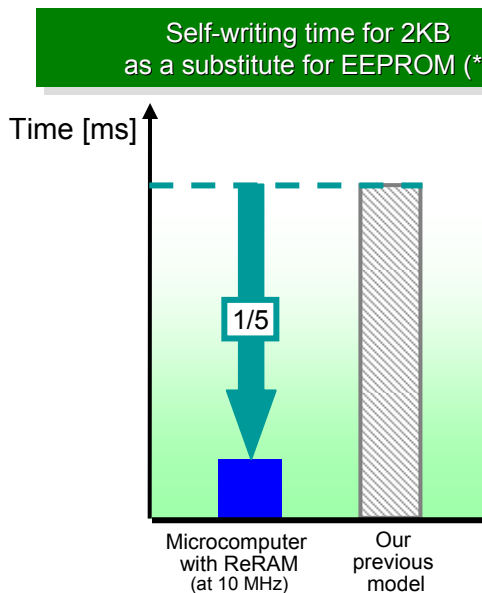
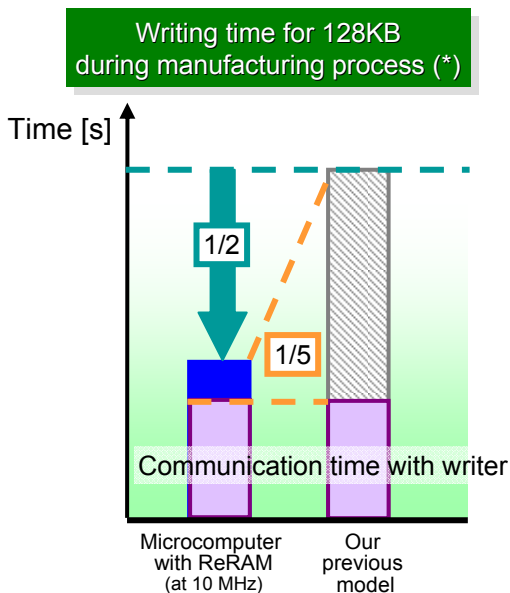

*) When writing a checker pattern (1,0,1,0..) in erase state (All "1").

50% lower power consumption with ReRAM and high-performance CPU

Thanks to low-power consumption ReRAM, shorter processing time and voltage control by high-performance CPU, and leakage current reduction of new fabrication process, power consumption has been reduced by 50%, compared to the existing Flash microcomputer.

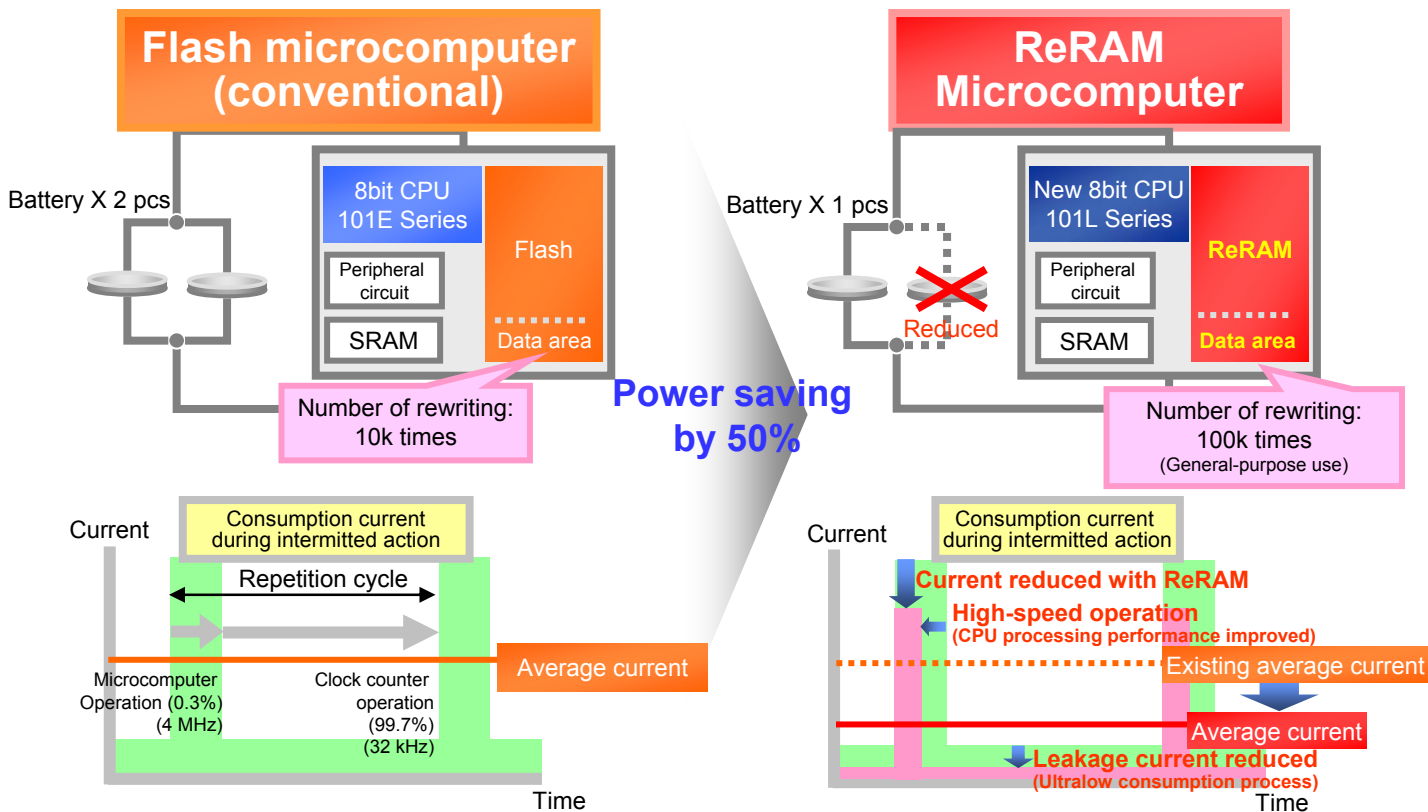

* Please note that these value are subject to change without prior notice.

8-bit AM1 (MN101) Series

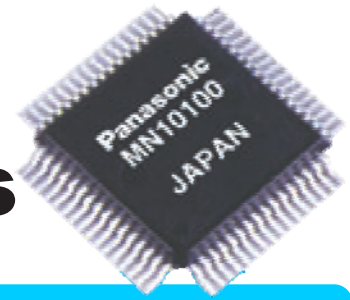

C Language Development for 8-bit High-performance Microcomputers

The AM1 Series of 8-bit microcomputers allows short-time program development in the C programming language. Its half-byte instruction set and other architectural features yield ROM code sizes that are small enough to rival those achieved with assembly language.

These devices are compact and have low power consumptions, yet offer high-speed operation with a minimum instruction execution time of 100 ns (at 5 V, 3 V)*1 and 50 ns (at 5 V, 3 V)*2

These microcomputers are suitable for a wide range of applications demanding high cost performance.

The MN101 Series consists of the MN101C, MN101E, and MN101L Series.

*1: MN101C and MN101L Series, *2: MN101E Series

C Language Oriented Architecture

Programs in C the same size or smaller as those in assembler

Powerful architectural features such as a half-byte instruction set and handy addressing, plus aggressive code optimization mean that the C compiler can generate ROM code that is the same size or smaller as that produced using assembly language. (This conclusion is based on comparison with previous Panasonic microcomputers.)

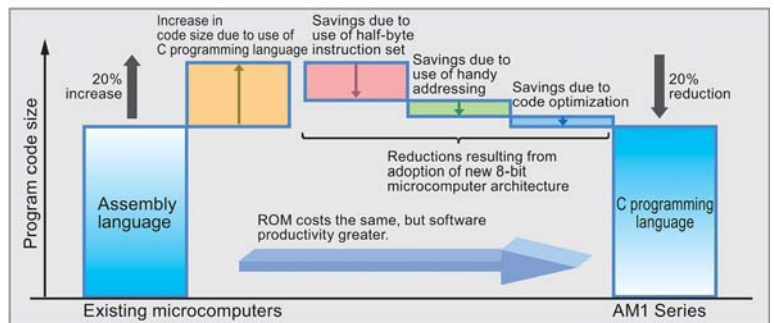

Half-byte Instruction Set

The Series adopts a variable-word length approach with basic instructions 1 byte long and extensions only 4 bits long. Since the resulting instruction set permits the specification of such operands as branch offsets and immediate values in units of four bits, instructions are shorter. Program sizes are therefore smaller.

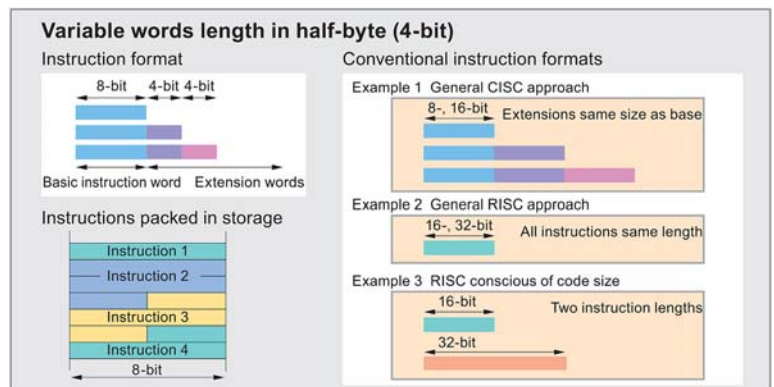

Handy Addressing

This technique focuses on the point that when variable data in memory is manipulated, load and store instructions will, in many cases, be to the same address. This technique allows the code size to be reduced by omitting the store instruction operand.

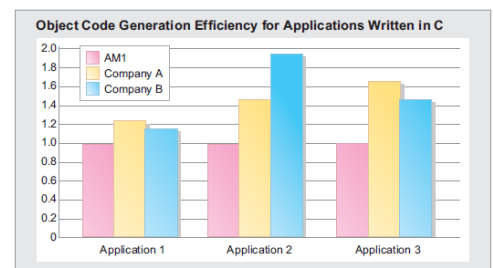
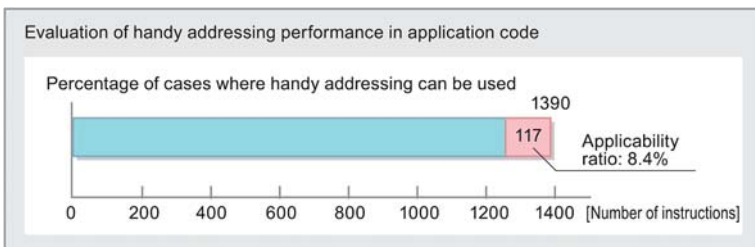
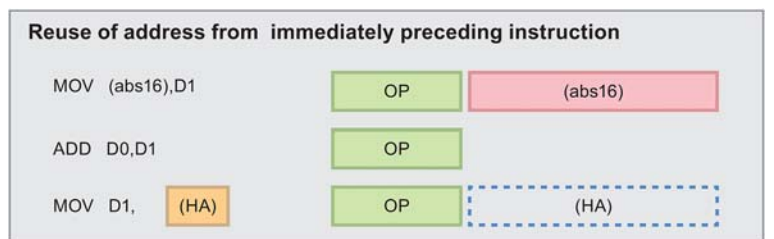

High-Speed Extended Memory Space Series (MN101E Series)

This series is upwardly compatible with the MN101C Series.

1 MB Linear Address Space

The 1 MB address space allows these microcontrollers to support more advanced and sophisticated systems.

	Memory space	Maximum on-chip ROM	Maximum on-chip RAM	Maximum operating frequency	Minimum instruction execution cycle
MN101C Series	256 KB	244 KB	11.75 KB	10 MHz	100 ns
MN101E Series	1 MB	944 KB	64 KB (Allocated in separate banks)	20 MHz	50 ns

Improved Processing Performance Series (MN101L Series)

Performance improved while maintaining compatibility with existing 8-bit microcomputer

MN101L Series has achieved higher processing performance and lower power consumption than those of existing 8-bit microcomputer (MN101E Series), based on new pipeline and ALU system configuration.

Enhanced processing performance and lower power consumption operation

Thanks to both the improved processing performance for memory access instruction by reviewing the pipeline and that for 16-bit data by using 16-bit bus, the MN101L Series has achieved the processing performance of 16-bit microcomputer even on 8-bit microcomputer hardware. (Dhrystone 2.1: 0.45 DMIPS/MHz; 1.75 times compared with existing core)

In addition, it supports one cycle I/O BUS access to allow fast peripheral circuit control.

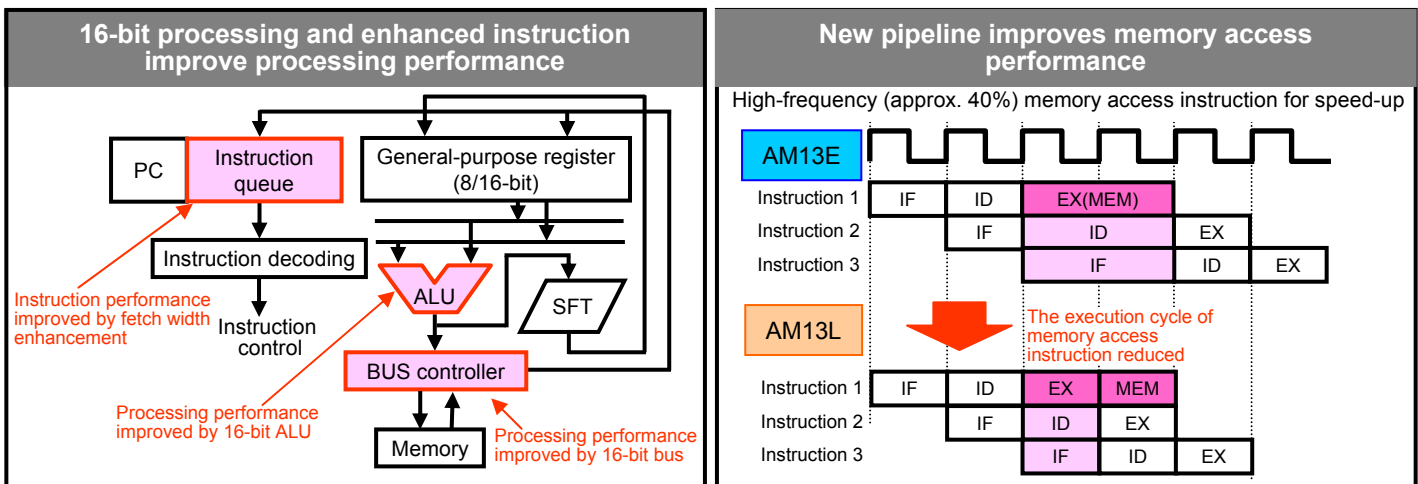

Extended calculation function

In addition to multiplication/division instruction of MN101E Series, the MN101L series allows calculation function such as BCD calculation to be implemented according to system needs, achieving higher cost performance microcomputer system for a variety of applications.

MN101 Series Applications

The series has low power consumption and high performance, allowing a variety of applications.

Sensor



Power

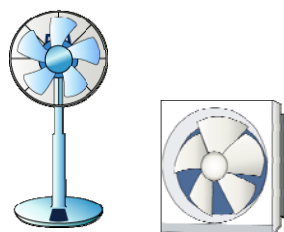

Automotive

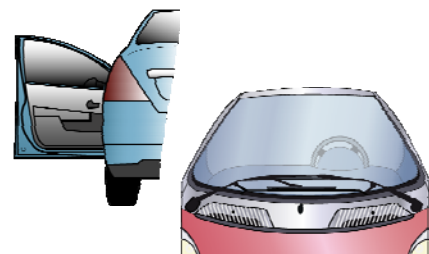

32-bit AM3 (MN103) Series



32-bit Microcomputer Controlling Equipment with Higher Processing Performance

The AM3 (MN103) Series of 32-bit microcomputers covers a broad range of applications from equipment control to multimedia processing.

The combination of a C language oriented architecture and optimizing compiler delivers both high performance and lower power consumption.

To streamline the development of applications high in both performance and functionality, these devices incorporate the AM Series standard on-chip I/O bus (C-bus) and the extended calculation instruction function for adapting them for ASSP enhancement and ASIC microcomputer development.

The MN103 Series consists of the MN103S, MN103H, and MN103L Series.

C Language Oriented Architecture

Optimizing compiler generates highly efficient instructions.

The optimizing compiler examines overall C program structure as it assigns variables to make most efficient use of the available registers. For frequently repeated loops, it preloads branch registers with the first instruction and the address of the next instruction. This small investment in additional hardware produces great advances in branch execution speed.

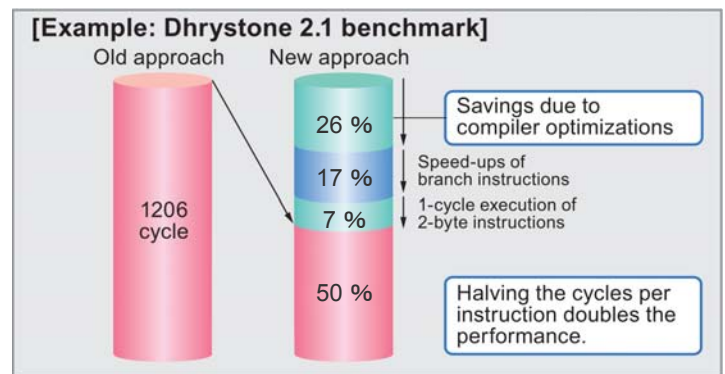

High Performance, Greater Efficiency

Minimum variable word lengths (8 bits) of instructions reduce program size.

Cutting program size is always a major issue in embedded microcomputer applications. The AM3 (MN103) Series organizes registers by function and is thus able to adapt a variable instruction length approach with a minimum length of only 8 bits. Making the most frequently used instructions shorter and then maximizing register usage with an optimizing C compiler minimizes program size. The AM3 (MN103) Series has eight basic registers available. It also uses a Harvard architecture with separate instructions and data memory to boost throughput by eliminating conflicts between instruction fetches and data access.

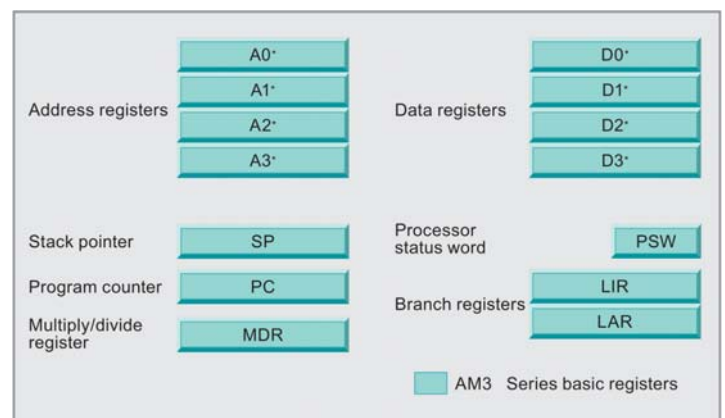

High-Performance Series for Inverter Control (MN103S/H Series)

Extended arithmetic function enhances equipment control performance.

The 103S/H Series provides a reserved instruction group and an extended arithmetic interface, to which high-speed multiplication/division and multiply-and-accumulate operation functions are appended according to system needs, in order to perform high-precision control in real time, thereby allowing high cost-performance microcomputer system suited for applications with inverter control.

Furthermore, MN103H Series capable of high-speed operation at 120 MHz is also provided to support advanced control devices. The series uses AM32R core, the same as that of MN103S Series, therefore allowing you to develop applications using the same tool.

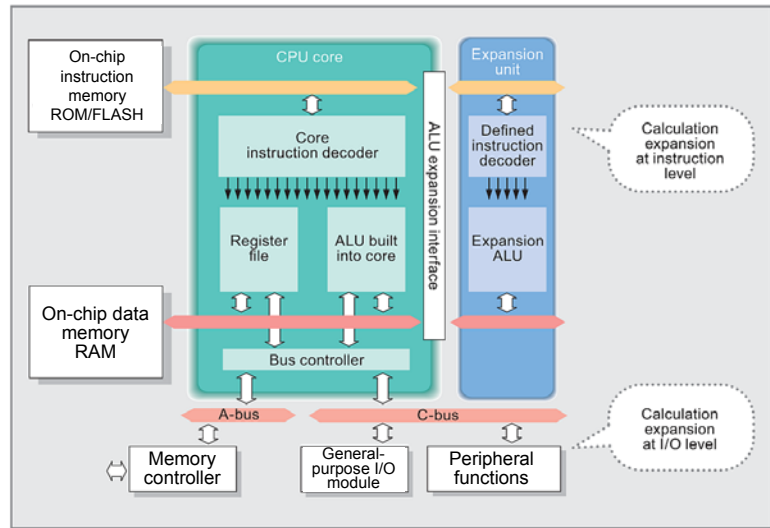

Low Power Series (MN103L Series)

Low power series offers instruction set compatibility with the MN103S Series

The MN103L Series features a simple architecture with a 3-stage pipeline that preserves instruction set compatibility in order to deliver optimal performance in the medium to low speed segment. Furthermore, it is able to deliver both high performance and low power consumption by implementing 32 extended instruction functions that are shared with the CPU's internal operations, including 32×32 high-speed multiplication and multiply-and-accumulate operations.

The series adopts 110-nm flash memory process with low leakage current technology, delivering low power consumption. In addition, it is based on the high-reliability technology, such as high-temperature operation for automotive applications, and memory data rewrites (100k times).

It can incorporate reset IC, oscillator, high multiplication PLL, and other high-accuracy analog circuits, which are external parts in previous model.

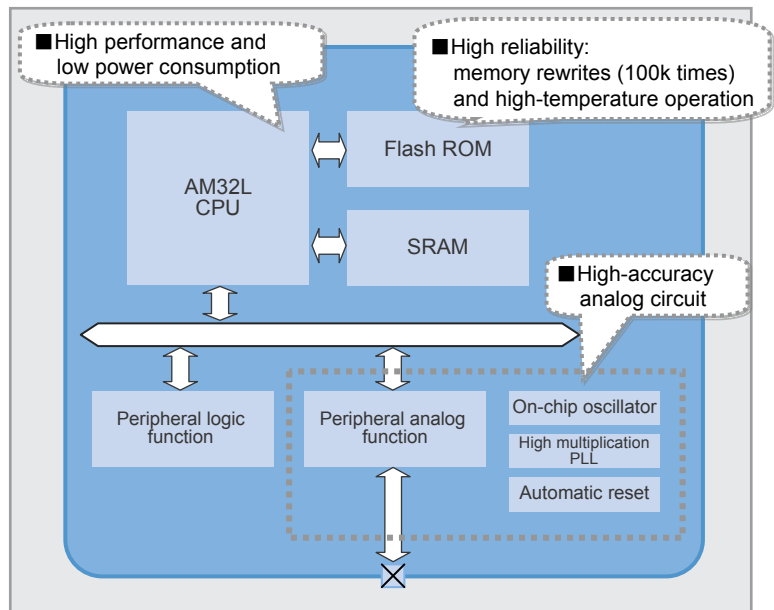

MN103 Series Applications

The high-performance features of the series allow a variety of applications.

Sensor



Power

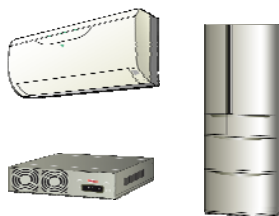

Automotive



Microcomputer with Improved Resistance to Noise

Why is Electromagnetic Compatibility (EMC) So Required Now?

As the functionality provided by the latest electronic equipment continues to advance, even higher integration levels and even higher speeds are required in their ICs. At the same time, the popularity of portable electronic equipment has led to demands for further miniaturization and lower operating voltages. To respond to these needs and demands, IC fabrication processes have moved to ever finer feature sizes, progressing in tandem with other IC developments.

Due to these advances, IC malfunctions due to noise are becoming a significant issue.

Since EMC problems largely depend on the PCB design, until now, EMC problems have been seen as an issue for end product design, and workarounds have largely focused on the end product. However due to the lower voltages and higher speeds of the latest equipment, it has become harder than ever to distinguish between noise and normal signals. This in turn makes workarounds in the end product harder to achieve. Therefore, improved resistance to noise at the independent IC level is becoming increasingly important.

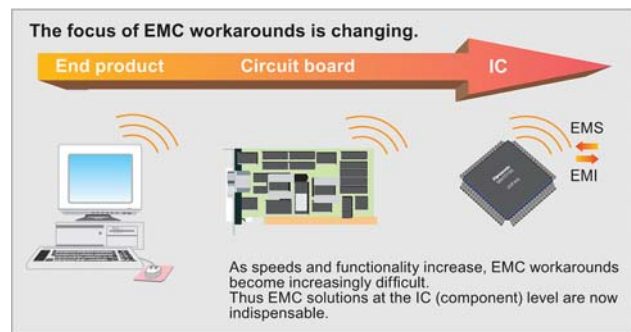

Examples of Improved EMC Performance

Achievement of both high noise immunity and low EMI

Panasonic has achieved a significant improvement in noise immunity over earlier products. Despite progress in process feature sizes, Panasonic has achieved even further improvements in voltage handling capacity. And assured better noise immunity than provided by earlier improved products, even in low-voltage process devices.

The following measures are implemented for EMC strengthening;

- EMS countermeasures (Electro Magnetic Susceptibility)
- EMI countermeasures (Electro Magnetic Interference)

Power line noise test

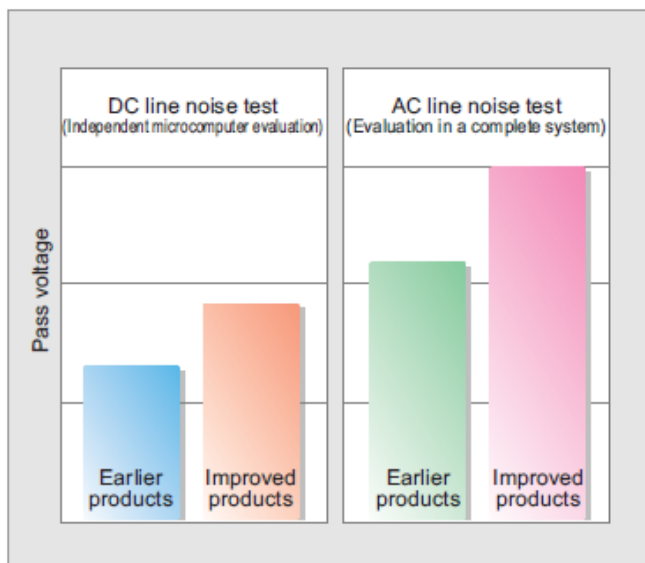

Loop radiation noise test

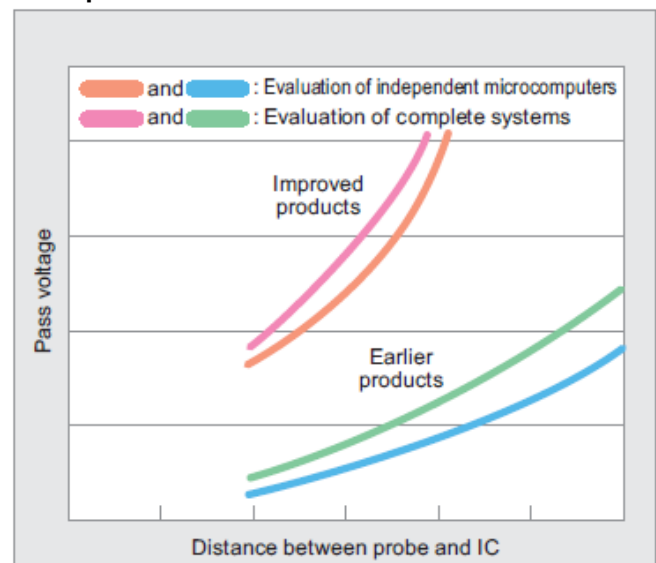

The DC line noise and loop radiation noise test methods were developed by Panasonic, and are based on two models, one for noise transmitted to the IC via conduction and one for noise transmitted to the IC via radiation.

To eliminate dependency of the test result on the application program, these tests are standardized with a common program that improves observability and a dedicated noise evaluation board.

EMS Countermeasures (EMS: Electromagnetic Susceptibility)

Cause of IC Malfunctions

The ICs used in electronic equipment are subject to a wide range of noise sources. These include power supply noise, electrostatic noise (ESD), radio noise, and spark noise from high-voltage components in the vicinity. These noise signals enter the end product through power supply lines and the chassis, affect the PCBs the ICs are mounted on, and finally impinge on the ICs. The following phenomena are thought to cause IC malfunctions in this type of environment.

- (1) Noise is superimposed on the input signals, the IC is unable to distinguish between noise and the actual input signals, and as a result, the IC malfunctions.
- (2) Power supply level fluctuations cause internal signal levels to fluctuate and the IC to malfunction.

What is the noise that enters ICs?

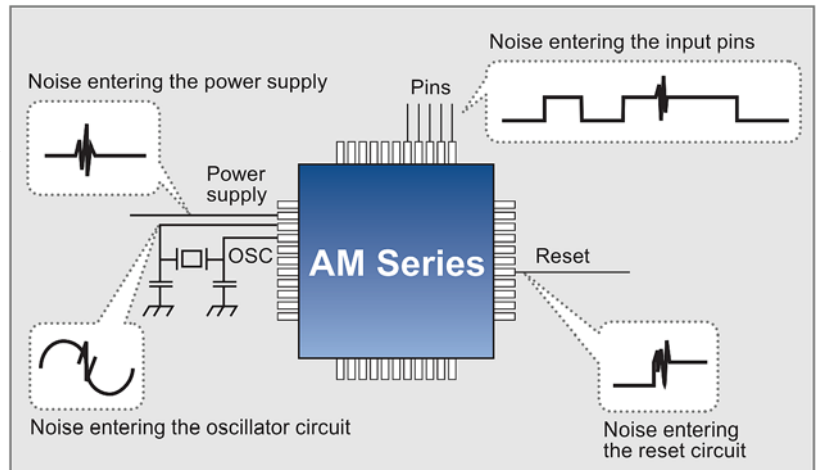

Enhancements to Noise Immunity Characteristics

Panasonic has enhanced the noise immunity of the AM microcomputers based on the following points.

- (1) Improved immunity to noise superimposed on input signals: Strengthening the ability to reject noise on the oscillator, reset, and interrupt signal pins.
- (2) Improved immunity to power supply fluctuations: Fabricating capacitors internally on the chip itself to both improve power supply stability and to suppress fluctuations in the power supply levels.
- (3) Operating mode stabilization: Optimizing the circuits to prevent unexpected mode transition due to noise.

EMI Countermeasures (EMI: Electromagnetic Interference)

Causes of EMI Emission in Electronic Equipment

ICs used in electronic equipment handle digital signals and generate harmonic currents. It is thought that the PCBs, wiring harnesses, and chassis in application systems act as antennas and radiate these high-frequency signals to the surrounding environment. Of these, harmonics due to the power supply currents associated with internal logic operation show little attenuation, and as a result can easily cause problems.

EMI generation mechanisms

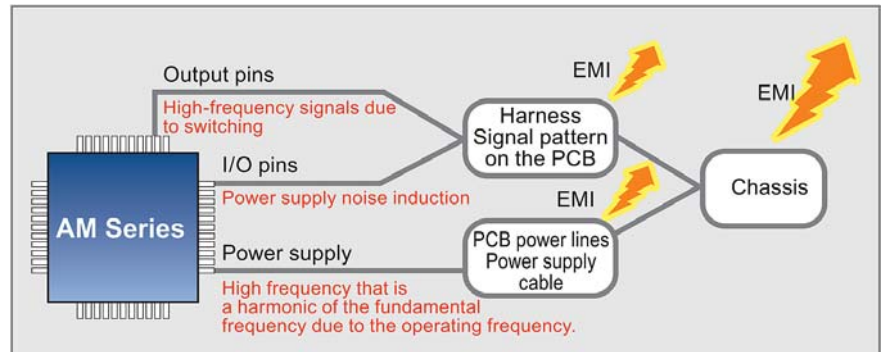

EMI Reduction Measures

The following EMI reduction measures are implemented in the AM microcomputers.

- (1) Improved decoupling capacitors: High-frequency noise leakage is suppressed by forming capacitors on the chip internal power supply lines.
- (2) Current smoothing: IC internal peak currents were reduced by implementing gated clock circuits, optimizing the clock driver circuits, and other measures.
- (3) Power supply isolation: Interference due to internal noise is prevented by isolating the CPU, I/O system, and analog system power supplies.

Furthermore, the noise power itself is reduced by achieving both reduced power consumption and reduced EMS.

In addition, it is now possible to create EMI countermeasures early in the IC design stage with EMI prediction technologies that use power supply current analysis technologies.

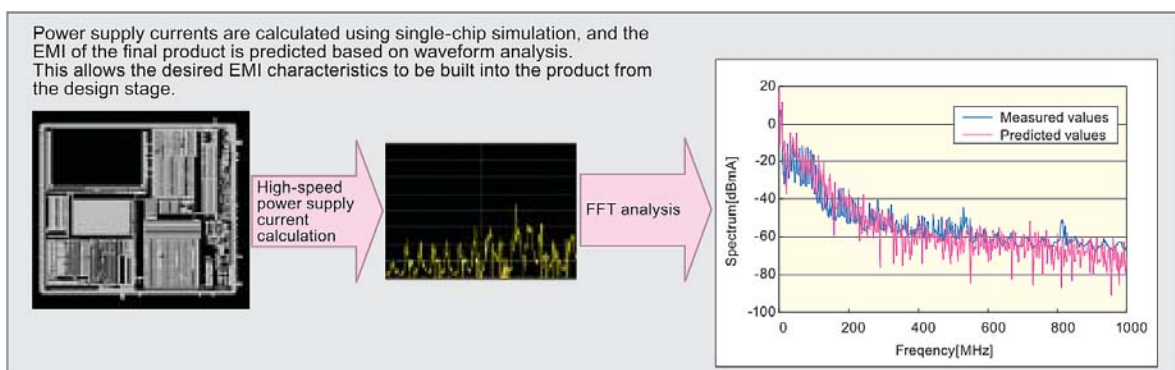

Development Environment

PanaXSeries®

PanaXSeries
TheOneToWatch for Constant Innovation-Making the Future Come Alive

Optimized C Compiler

Delivers compact, fast code generation suitable for microcomputers.

Panasonic compilers maximize the performance of AM microcomputer by implementing both general optimization and original optimization that utilizes high functionality instructions of each microcomputer. In addition, these compilers feature a language extension function and extensive utilities to support development process from program description to a write to ROM.

C compiler supporting AM1 (MN101C/MN101E/MN101L) Series

- High code generation efficiency required for 8-bit microcomputer
 - Extending and modifying parts of the ANSI C specifications takes maximum advantage of the 8-bit microcontroller instruction set
 - Code generation utilizing the characteristic of AM1 Series, such as half-byte instruction and handy addressing
 - Optimization by instruction unit such as new instruction scheduling, register trace, and optimized resource assignment
- Advanced operability
 - Operation by integrated environment **DebugFactory® Builder**
 - Simple operation by command line

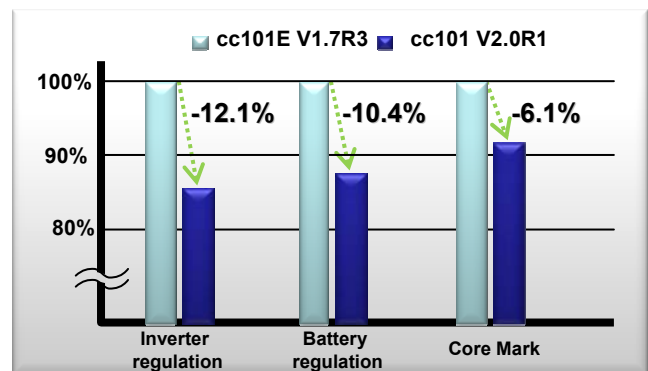

Comparison of Code Size and Conventional Compiler

C compiler supporting AM3 (MN103S/MN103H/MN103L) Series

- Superior language extension
 - Extended inline assembler allowing a seamless connection between variables in C and registers in assembler
 - Corresponding to long-long type (C99 standard)
- Higher code generation and execution performance both achieved
 - Balanced optimization between increasing execution speed (function in-line expansion, loop expansion, instruction scheduling) and increasing efficiency of code generation (common subexpression, tail merge)
- Compliant with a global standard, ANSI
- High performance both in control processing and media processing *1
 - Speeding up of function call by using high-functional subroutine call instruction
 - Faster loop processing by using loop first instruction and also branching instruction for loop
- Advanced operability
 - Operation by the integrated environment **DebugFactory® Builder**
 - Simple operation by command line

*1: Depending on microcomputer type

Utility tools

- Stack consumption analytical tool
 - Displays a list of indirect call function and recursive function.
 - Displays the maximum value of accumulated stack consumption by specifying the auxiliary information (functions called indirectly, and recursive count).
- Unused symbol (variable/function) detection tool
 - Displays a list of unused variables and functions for reducing ROM.
- Executable format file dump tool (AM1 Series)
 - Allows optimized code to be output from executable format file when linked.

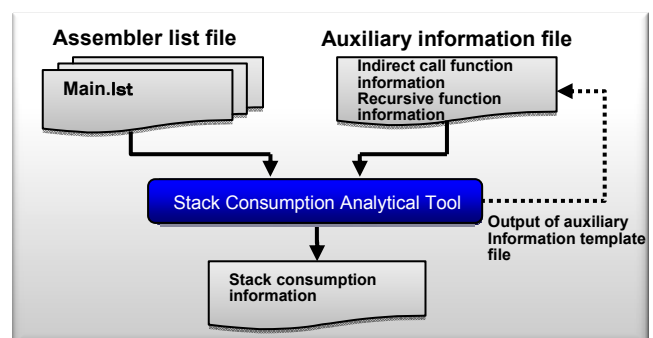

Stack Consumption Analytical Tool

DebugFactory® Builder Version 5

Microcomputer software integrated development environment

DebugFactory Builder streamlines the microcomputer software development process by allowing you to repeatedly perform the sequence of debugging operations such as editing source files, performing builds (generating make files and compiling), and debugging code on a single application. Enhanced support functions for source code edit, build, and debugging make software development effective.

Source code edit support function

- Code navigation
 - Reduces coding and debugging time by a quick access to desired information in source code, such as input candidate list display and function format display, and jump to function/variable definition and declarative positions.
- I/O control sample code display
 - Reduces development time by using sample code for built-in timer function and serial function control for microcomputer

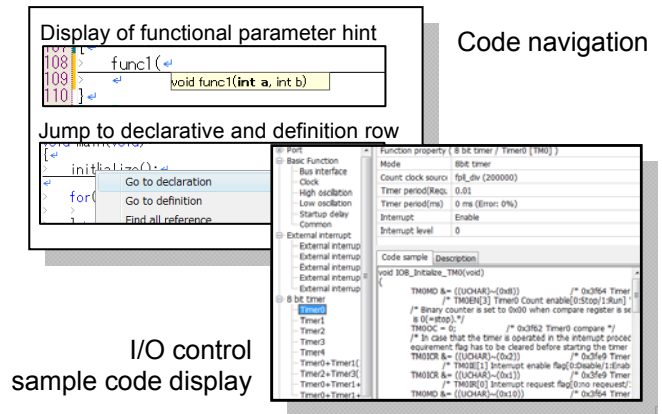

Build support function

- Automatic compiling function
 - Reduces build time by performing source code retention and compiling in the background at the same time.
- Compile error display on editor
 - Displays the compile error point on editor to allow compile error to be corrected.
- Significantly enhanced, higher built-in make function
 - Delivers the function equivalent to commercial make file.
 - Reduces make time by reading and internally converting recursive make file.

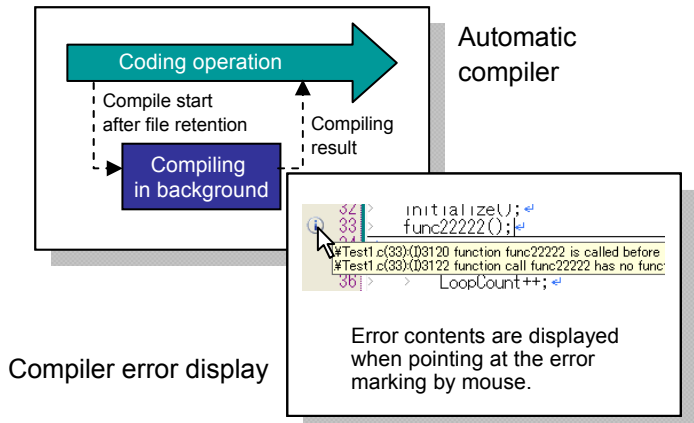

Debugging support function

- Special register setting value / pin value check
 - Displays a list of special register setting values or pin values to enable a quick error detection.
- Debug window designer
 - Allows custom window to be created, in which button and check box used for debugging are assigned.
 - Assigns various operations to each button, allowing multiple operations to be executed with just one click.
 - Assigns display panels and buttons of real target to the window of personal computer to build a virtual target, allowing a debugging before hardware is available.

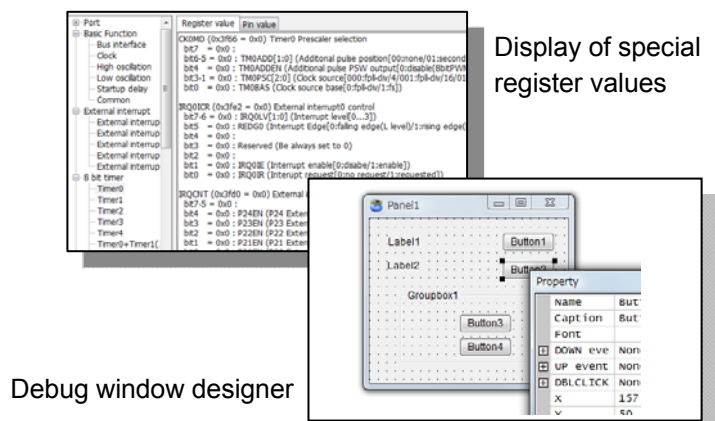

On-board Environment

Low-cost on-board debugging and programming environment PanaX® EX Series

- Embedded microcomputer on-board debugging and flash programming environment (Flash programming supports mass-production writing.)
- Delivers high-speed operation despite low cost.
- Supports the MN101C, MN101E, MN101L, MN103L, MN103S, and MN103H Series.
- Provides attached debugger (DebugFactory Builder) and programmer software (EX Commander) for each microcomputer series.
Installing additional product definition file allows new products to be supported.
- Target connection types include 14- and 10-pin box connectors and compact flexible cables.
- Optional remote control
- Connecting maximum eight PanaX® EX to personal computer through USB HUB enables gang-programming.
- Four kinds of lineup to meet customer needs



PanaX EX1



PanaX EX2

Feature / Cost	EX1	Low-cost version (Always use, connecting with host PC)
	EX2	Stand-alone version (Available for stand-alone programming without host PC)
Target connecting method	Standard edition	Regular connecting with target
	Insulated edition	Electrically-insulated connection with target

High-speed and highly-functional PanaX® NEO On-Board Debugging Environment

- High-speed and highly-functional on-board debugging environment with hardware assist
- When used with trace pin-equipped hardware, an optional data gathering unit enables real-time trace functionality for capturing program execution log data.
- Standard host computer connectivity is via USB1.1/2.0 and Ethernet 10Base-T /100Base-TX.

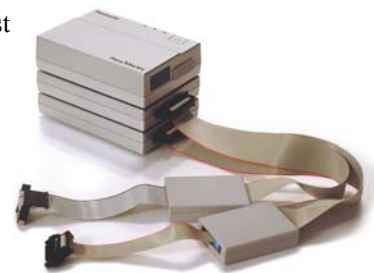

PanaX® EX Programming System

Low-cost stand-alone programming environment

- As with existing parallel programmer, mounting microcomputer on socket board enables stand-alone programming.
- PanaX® EX is also available for debugging.
- Supports a variety of products by changing socket board.
- Offers low-cost and fast programming compared with the existing parallel programmer environment (PX-FW2)
- Connecting multiple PanaX® EX programming system to personal computer through USB HUB enables gang programming.

(Note) EX Series whose target connecting method is an insulated edition is not available.



In-Circuit Emulator (ICE)

ICE supporting a system development with advanced debug function.

Supports debugging with extensive functions such as break function, real-time trace function for instruction execution history, RAM monitoring function that visualizes RAM data change without stopping the target program.

PX-ICE101C/E-Advance, PX-ICE103L

- Real-time emulation
 Integration of emulator circuit and high-density mounting technology provides high-speed real-time emulation.
- Equipped with large-capacity emulation memory
- Extensive event / break / trace functions
 - Allow hardware break point to be used as trigger event for various debug functions.
 - Connect multiple events on sequential, AND, and other conditions, allowing easy debugging even in a difficult situation.
 - Provide a versatile, convenient trace operation mode such as event-conditioned delayed trigger and so on.
- On-the-fly function
 Enables memory reference, and event, break, and trace settings and display without stopping target program execution
- Sampling function
 - High-precision profile
 (Approx. 300 times sampling rate compared with existing Panasonic ICE)
 - High-speed RAM sampling
- Supports low-voltage devices.
- Supports a wide variety of products .
 (For specific products supported, please see our website.)

(Note) PX-ICE101C/E-Advance is not available to MN101L Series.



ICE101C/E-Advance



ICE103L

PX-ICE101C/E-Lite

- Well-selected functions have reduced the cost.
- Boards depending on each microcomputer are commonly used for both this product and PX-ICE101C/E-Advance.
 (For specific supporting products, please see our website.)

(Note) Not available to MN101L Series



Real-time Operating Systems

Operating systems that deliver the real-time performance and compact footprint needed for embedded devices

These real-time operating systems comply with the industry-standard μ ITRON 4.0 Specification.

- They provide an OS kernel that implements scalable specifications so that it can be applied in hardware ranging from small to large-scale systems.
 - Light edition
 - It provides a low-memory implementation that is ideal for small-scale systems.
 - Standard edition
 - It implements high-speed processing along with a standard function set that can be applied to even large-scale systems. Synchronous communications between processors are implemented via the μ ITRON 4.0 standard SVC.
- A development environment that complies with the ITRON debugging interface specifications is provided.
 - Resource information display function, trace log analysis function, and break function with real-time OS support

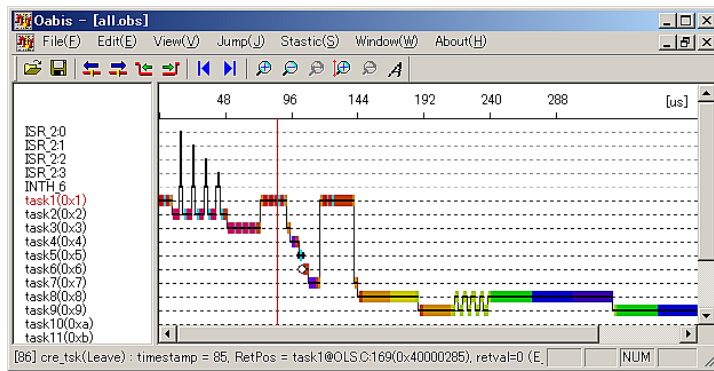

Trace log analytical functions

		Light Edition		Standard Edition
■ Specifications		Compliant with μ ITRON4.0 Specification Automobile Control Profile		Compliant with μ ITRON4.0 Specification Standard Profile
■ Compatible microcomputers		MN101C/MN101E Series	MN103S/MN103H/MN103L Series	MN103S/MN103H Series
■ Basic specifications		16 Standard tasks: 4 states Constrained tasks: 3 states Priority-based event drive method (Same priority: FCFS)	256 Standard tasks: 4 states Constrained tasks: None Priority-based event drive method (Same priority: FCFS)	256 Standard tasks: 7 states Constrained tasks: None Priority-based event drive method (Same priority: FCFS)
■ Static APIs		8 types (Proprietary configuration format)		
■ No. of service calls		56 types	69 types	160 types
• Task management		Yes	Yes	Yes
• Task-attached synchronization		Yes	Yes	Yes
• Task exception processing		No	No	Yes
• Synchronization/communications		Yes: Semaphores, event flags, data queues, mailboxes	Yes: Semaphores, event flags, data queues, mailboxes	Yes: Semaphores, event flags, data queues, mailboxes, mutex, message buffers, condition variables
• Memory pool management		No	Yes: Fixed-length memory pools	Yes: Fixed-length memory pools, variable-length memory pools
• Time management		Yes	Yes	Yes
• System state management		Yes	Yes	Yes
• Interrupt management		Yes	Yes	Yes
• System architecture management		No	Yes	Yes
■ Max. no. of OS resources		16 of each	16 of each	16 of each
■ Memory	ROM	1KB to 5.5KB	5KB to 20KB	20KB to 50KB
	RAM	200 bytes to several tens of KB	200 bytes to several tens of KB	2K bytes to several MB
■ Service call speed		6 to 172[μ s]	38 to 660[cycle]	28 to 667[cycle]
■ Interrupt response	Under OS management	20 to 127[μ s] 6 to 172[μ s]	61 to 721[cycle]	78 to 745[cycle]
	Not under OS management	20 to 33[μ s]	61[cycle]	78[cycle]
■ Build environment		DOS	DOS and Gmake support (Cygwin + Linux), DF * Task-specific static stack use calculation	
■ OS debugging functionality		Task trace function (CPU utilization rate display, transition display, acquisition time: 0.5 s to 10 s) OS resource state display (state and other information for tasks, etc; back-tracing for individual tasks; dynamic stack calculation, etc.)		
■ Example target product fields		White goods, compact control equipment	DVD players, SD audio	DTV / DSC / Movie / Onboard vehicle audiovisual

Programming Tools Available from Panasonic Business Partners

In Circuit Flash Programmer (Yokogawa Digital Computer Corp.)

- Simultaneous multi-control model: G-NETIMPRESS
- Standard model: NETIMPRESS
- Mass production line support, DLLs provided, sequencer control, bar-code hardware switching, support for unique data (serial, correction value, etc.) programming

<http://www2.yokogawa-digital.com/en/>



Flash Programmer (Flash Support Group, Inc.)

- Extensive product line includes parallel programmers, on-board programmers, gang programmers, and related equipment.
- Products support high-volume programming with automated programming and on-board programming systems.
- Company offers programming services for Panasonic microcontrollers in Japan and China

<http://www.j-fsg.co.jp/e/prod/pro01.html>

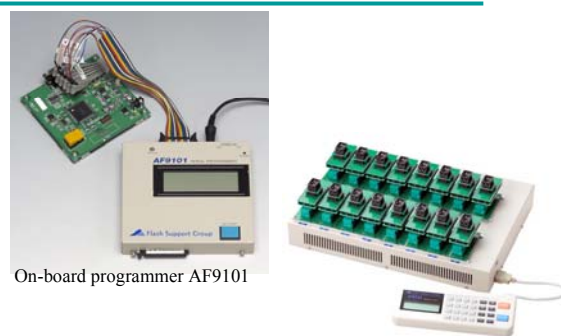

On-board programmer AF9101

Gang programmer AF9724

On-board Tools (OBJECT Co., LTD.)

- Provide support for both debuggers and programmers in a single package.
- Support the MN101C/E and MN103S/L Series.
- Deliver faster performance than conventional products.
- Support stand-alone offline operation (no computer required).
- Provide robust protection with a digital isolator.
- Include a full C compiler and are available at a reasonable price.

http://www.object.co.jp/panamc/panamc_eng/amot/index.html

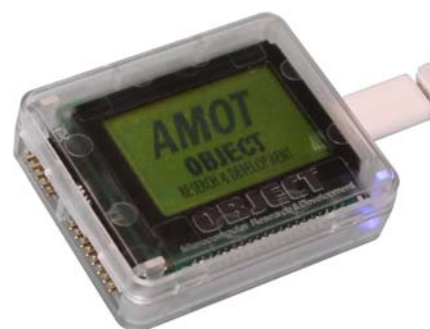

Evaluation Starter Kit (OBJECT Co., Ltd.)

- All-in-one package is ideal for AM microcomputer education and deployment evaluation
- Includes CPU board, host connection cable, debugger, evaluation edition C compiler, sample programs, and associated documentation.
- Connects directly to the host computer with a USB cable for easy debugging (no external power supply required).
- Equipped with two 7-segment LEDs, two 2-color LEDs, a reset switch, and an interrupt switch.
- The target device (microcomputer on the user's target hardware) can also be debugged using DIP switch settings (same model only).
- Microcomputer I/O can be connected to an external device via an expansion connector (includes unmounted components).

http://www.object.co.jp/panamc/panamc_eng/amskdw/index.html



Package List

Package type	Package size (mm)	Pin pitch (mm)	Number of pins																		
			20	22	24	28	32	42	44	48	52	64	76	80	84	100	128	144	152	176	257
FLGA	11 X 11	0.8																	●		
UBGA	7 x 7	0.50																	●		
	11 x 11	0.50																			●
HQFN	4 x 4	0.40					●														
	5 x 5	0.50					●														
	5 x 7	0.40							●												
SSOP	6.1 x 11	0.65					●														
SOP	5.5 x 12.63	1.27	●																		
	7.2 x 17.8	1.27				●															
	7.2 x 15.27	1.27		●																	
TQFP	7 x 7	0.80					●														
	7 x 7	0.50							●												
	10 x 10	0.50								●											
	12 x 12	0.65									●										
	12 x 12	0.50										●									
	14 x 14	0.40											●						●		
LQFP	7 x 7	0.50							●												
	14 x 14	0.80									●										
	14 x 14	0.65										●									
	14 x 14	0.50											●				●				
	18 x 18	0.50															●				
	20 x 20	0.50																●			
	24 x 24	0.50																	●		
HQFP	7 x 7	0.50							●												
QFP	10 x 10	0.80							●												
	14 x 14	0.80									●										
	18 x 18	0.80										●				●					
	18 x 18	0.65														●					

■ Package Outline

•FLGA



•UBGA



•HQFN



•SSOP

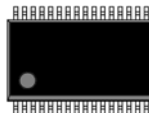

•SOP

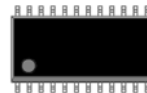

•TQFP

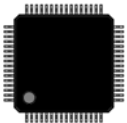

•LQFP

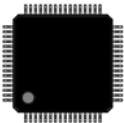

•HQFP

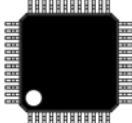

•QFP

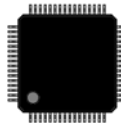

Contact Information

Website

Panasonic Microcomputer

Panasonic Microcomputer product information is available online.

<http://www.semicon.panasonic.co.jp/en/products/microcomputers/>

- Development tool information : <http://www.semicon.panasonic.co.jp/e-micom/support.html>
- Document downloads : <http://www.semicon.panasonic.co.jp/e-micom/document.html>
- Inquiry : <http://www.semicon.panasonic.co.jp/e-micom/qa.html>

Semiconductor Technical Support System

Panasonic provides information overviews by email, and customers can obtain more information by clicking the included link for the Panasonic Semiconductor Technical Support System.

The customer site is also available to ask questions and download development tools.

User registration for access

Please access the following URL and register as a user.

<https://www.semicon.panasonic.co.jp/semi-spt/general/?lang=en&>

Rental Company

Company	Products	URL
Orix Rentec Corporation	PanaX Series rentals	http://www.orixrentec.jp/cgi/en/

Business Partner

Company	Products	URL
Kyoto Microcomputer Co., Ltd.	On-board debugging environments, compilers	http://www.kmckk.co.jp/eng/index.html
Red Hat, Inc.	Compiler	http://www.redhat.com/
Yokogawa Digital Computer Corporation	On-board programmers, quality performance measurement tools	http://www2.yokogawa-digital.com/en/
Flash Support Group, Inc.	On-board programmers, parallel programmers, gang programmers, parallel write adapters	http://www.j-fsg.co.jp/en/index.html
Wave Technology Co., Ltd.	Gang programmers	http://www.wavetechnology.co.jp/en/index.html
OBJECT Co., Ltd.	On-board programmers, starter kits, on-board debugging environments	http://www.object.co.jp/
Tokyo Eletech Corporation	Device mounting sockets, ICE connection adapters	http://www.tetc.co.jp/e_index.htm
Abity	PanaX Series manufacturing, repair, and shipment management	http://www.abity.jp
GAIO TECHNOLOGY CO., LTD.	Embedded module standalone testing and coverage measurement automation tools	http://www.gaio.com/
JOHNAN Corporation	Support for writing to Flash microcomputer	http://www.johnan.com/en/

Linux is a registered trademark of Linus Torvalds.

TRON is an abbreviation of "The Real-time Operating system Nucleus."

ITRON is an abbreviation of "Industrial TRON."

μITRON is an abbreviation of "Micro Industrial TRON."

TRON, ITRON, and μITRON do not refer to any specific product or products.

PanaXSeries, PanaX, and DebugFactory are registered trademarks of Panasonic Corporation.

Other corporation names, logotypes, and product names written in this document may be trade names, trademarks, or registered trademarks of their respective owners.

Request for your special attention and precautions in using the technical information and semiconductors described in this book

- (1) If any of the products or technical information described in this book is to be exported or provided to non-residents, the laws and regulations of the exporting country, especially, those with regard to security export control, must be observed.
- (2) The technical information described in this book is intended only to show the main characteristics and application circuit examples of the products. No license is granted in and to any intellectual property right or other right owned by Panasonic Corporation or any other company. Therefore, no responsibility is assumed by our company as to the infringement upon any such right owned by any other company which may arise as a result of the use of technical information described in this book.
- (3) The products described in this book are intended to be used for general applications (such as office equipment, communications equipment, measuring instruments and household appliances), or for specific applications as expressly stated in this book. Consult our sales staff in advance for information on the following applications: Special applications (such as for airplanes, aerospace, automotive equipment, traffic signaling equipment, combustion equipment, life support systems and safety devices) in which exceptional quality and reliability are required, or if the failure or malfuncion or harm the human body. It is to be understood that our company shall not be held responsible for any damage incurred as a result of or in connection with your using the products described in this book for any special application, unless our company agrees to your using the products in this book for any special application.
- (4) The products and product specifications described in this book are subject to change without notice for modification and/or improvement. At the final stage of your design, purchasing, or use of the products, therefore, ask for the most up-to-date Product Standards in advance to make sure that the latest specifications satisfy your requirements.
- (5) When designing your equipment, comply with the range of absolute maximum rating and the guaranteed operating conditions (operating power supply voltage and operating environment etc.). Especially, please be careful not to exceed the range of absolute maximum rating on the transient state, such as power-on, power-off and mode-switching. Otherwise, we will not be liable for any defect which may arise later in your equipment. Even when the products are used within the guaranteed values, take into the consideration of incidence of break down and failure mode, possible to occur to semiconductor products. Measures on the systems such as redundant design, arresting the spread of fire or preventing glitch are recommended in order to prevent physical injury, fire, social damages, for example, by using the products.
- (6) Comply with the instructions for use in order to prevent breakdown and characteristics change due to external factors (ESD, EOS, thermal stress and mechanical stress) at the time of handling, mounting or at customer's process. When using products for which damp-proof packing is required, satisfy the conditions, such as shelf life and the elapsed time since first opening the packages.
- (7) This book may be not reprinted or reproduced whether wholly or partially, without the prior written permission of our company.

Semiconductor Business Division
Automotive & Industrial Systems Company
Panasonic Corporation

1 Kotari-yakemachi, Nagaokakyo City, Kyoto
617-8520, Japan
Tel : 81-75-951-8151

<http://www.semicon.panasonic.co.jp/en>